

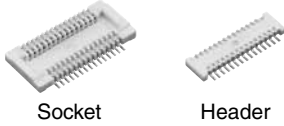

**NARROW-PITCH CONNECTORS FOR BOARD-TO-BOARD CONNECTION**

**NARROW PITCH (0.5mm) CONNECTORS P5 SERIES — P5KL —**



**Compliance with RoHS Directive**

**FEATURES**

1. Low profile mating height of 1.2 mm with 0.5 mm pitch, was obtained. It contributes to device compactness.
2. Strong resistance to adverse environments! Utilizes **TOUGH CONTACT** construction for high contact reliability. (See Page 6 for details of the structure)
3. Simple lock structure employed to further increase connection reliability

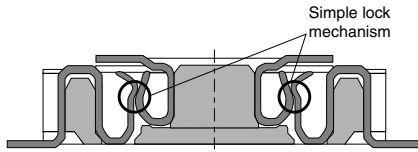

**4. Effective mating length 0.3 mm**

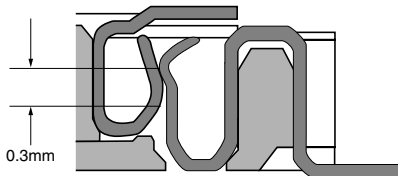

**APPLICATIONS**

Compact portable devices “Cellular phones, DVC, Digital cameras, etc”

Ideal for Board-to-FPC connections

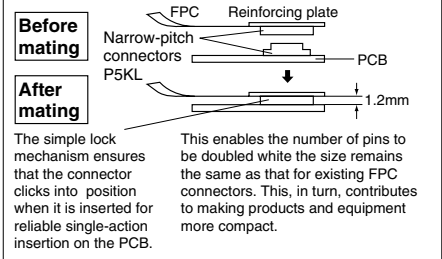

**ORDERING INFORMATION**

AXK             3    7 G

5L: Narrow Pitch Connector P5KL (0.5 mm pitch) Socket  
 6L: Narrow Pitch Connector P5KL (0.5 mm pitch) Header

Number of contacts (2 digits)

Mated height  
 <Socket>

3: For mated height 1.2 mm  
 <Header>

3: For mated height 1.2 mm

Functions

3: With positioning bosses  
 4: Without positioning bosses

Surface treatment (Contact portion / Terminal portion)

7: Ni plating on base, Au plating on surface (for Ni barrier available)

Packing

G: 3,000 pieces embossed tape and plastic reel × 2 (for Ni barrier available)

# AXK(5/6)L

## PRODUCT TYPES

Mated height	No. of contacts	Part No.		Packing quantity	
		Socket	Header	Inner carton (1-reel)	Outer carton
		<b>TOUGH CONTACT</b>	<b>TOUGH CONTACT</b>		
1.2 mm	10	AXK5L10347G	AXK6L10347G	3,000 pieces	6,000 pieces (2-reel)
	12	AXK5L12347G	AXK6L12347G		
	20	AXK5L20347G	AXK6L20347G		
	24	AXK5L24347G	AXK6L24347G		
	30	AXK5L30347G	AXK6L30347G		
	34	AXK5L34347G	AXK6L34347G		
	40	AXK5L40347G	AXK6L40347G		
	46	AXK5L46347G	AXK6L46347G		
	50	AXK5L50347G	AXK6L50347G		
60	AXK5L60347G	AXK6L60347G			

- Notes) 1. Regarding ordering units: During production, Please make orders in 1-reel units. Samples for mounting confirmation: Please consult us. Samples: Small lot orders are possible. Please consult us.  
 2. The standard type comes without positioning bosses. Connectors with positioning bosses are available for on-demand production.  
 For this type of connector, 9th digit of the part no. changes from 4 to 3. e.g. 10 contacts for sockets: AXK5L10337G  
 3. Previous non-**TOUGH CONTACT** types and current **TOUGH CONTACT** types are compatible for mating.

## SPECIFICATIONS

### 1. Characteristics

	Item	Specifications	Conditions
Electrical characteristics	Rated current	0.5A/contact (Max. 10 A at total contacts)	
	Rated voltage	60V AC/DC	
	Breakdown voltage	150V AC for 1 minute	Detection current: 1mA
	Insulation resistance	Min. 1,000M $\Omega$ (initial)	Using 500V DC megger
	Contact resistance	Max. 90m $\Omega$	Based on the contact resistance measurement method specified by JIS C 5402.
Mechanical characteristics	Composite insertion force	Max. 0.981N {100gf}/contacts $\times$ contacts (initial)	
	Composite removal force	Min. 0.0588N {6gf}/contacts $\times$ contacts	
	Holding force of terminal securing section	Min. 0.981N {100gf}/contact	Measuring the maximum force. As the contact is axially pull out.
Environmental characteristics	Ambient temperature	-55°C to +85°C	No freezing at low temperatures
	Soldering heat resistance	Max. peak temperature of 260°C (on the surface of the PC board around the connector terminals)	Infrared reflow soldering
		300°C within 5 seconds 350°C within 3 seconds	Soldering iron
	Thermal shock resistance (header and socket mated)	5 cycles, insulation resistance min. 100M $\Omega$ , contact resistance max. 90m $\Omega$	Sequence 1. -55 $\frac{3}{5}$ °C, 30 minutes 2. ~, Max. 5 minutes 3. 85 $\frac{3}{5}$ °C, 30 minutes 4. ~, Max. 5 minutes
	Humidity resistance (header and socket mated)	120 hours, insulation resistance min. 100M $\Omega$ , contact resistance max. 90m $\Omega$	Bath temperature 40 $\pm$ 2°C, humidity 90 to 95% R.H.
	Saltwater spray resistance (header and socket mated)	24 hours, insulation resistance min. 100M $\Omega$ , contact resistance max. 90m $\Omega$	Bath temperature 35 $\pm$ 2°C, saltwater concentration 5 $\pm$ 1%
H <sub>2</sub> S resistance (header and socket mated)	48 hours, contact resistance max. 90m $\Omega$	Bath temperature 40 $\pm$ 2°C, gas concentration 3 $\pm$ 1 ppm, humidity 75 to 80% R.H.	
Lifetime characteristics	Insertion and removal life	50 times	Repeated insertion and removal speed of max. 200 times/hours
Unit weight		20 contacts; Socket: 0.05g; Header: 0.02g	

### 2. Material and surface treatment

Part name	Material	Surface treatment
Molded portion	Heat-resistant resin (UL94V-0)	—
Contact/Post	Copper alloy	Contact portion: Ni plating on base, Au plating on surface Terminal portion: Ni plating on base, Au plating on surface (Except for thick of terminal) The section close to the soldering portion has a nickel barrier. (The nickel base is exposed.)

## DIMENSIONS (Unit: mm)

The CAD data of the products with a **CAD Data** mark can be downloaded from: <http://panasonic-electric-works.net/ac>

- Socket (Mated height: 1.2mm)

### CAD Data

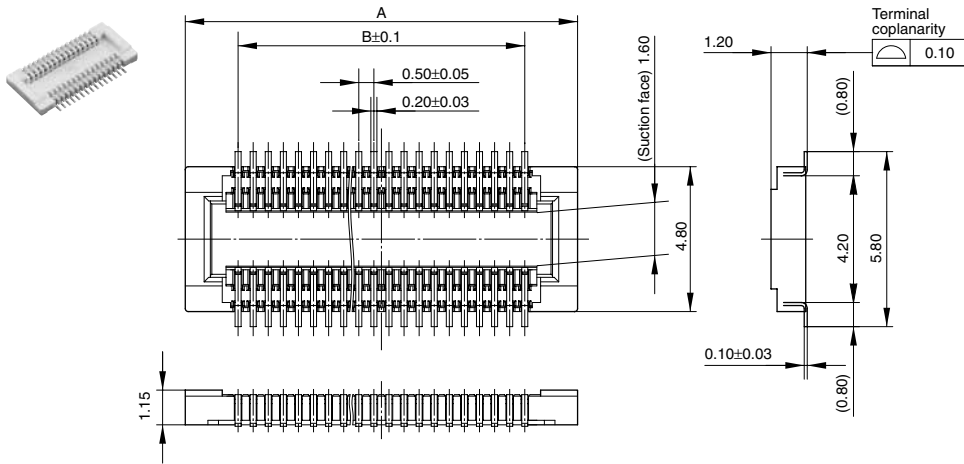

Dimension table (mm)

No. of contacts	A	B
10	5.50	2.00
12	6.00	2.50
20	8.00	4.50
24	9.00	5.50
30	10.50	7.00
34	11.50	8.00
40	13.00	9.50
46	14.50	11.00
50	15.50	12.00
60	18.00	14.50

General tolerance:  $\pm 0.2$

- Header (Mated height: 1.2mm)

### CAD Data

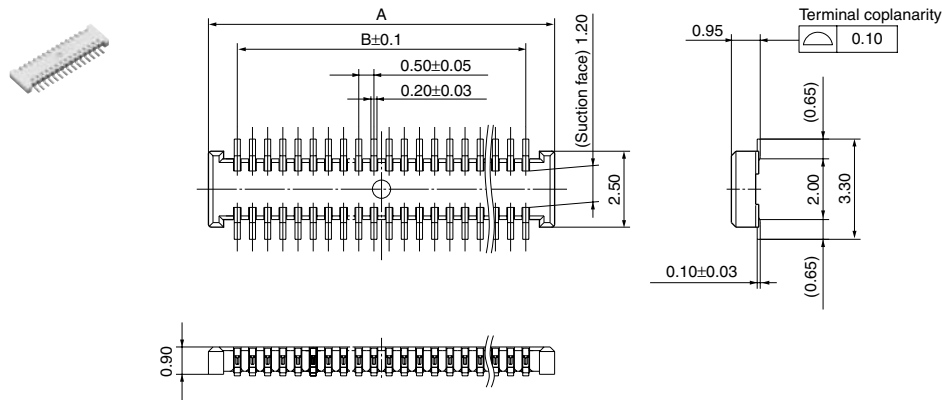

Dimension table (mm)

No. of contacts	A	B
10	3.90	2.00
12	4.40	2.50
20	6.40	4.50
24	7.40	5.50
30	8.90	7.00
34	9.90	8.00
40	11.40	9.50
46	12.90	11.00
50	13.90	12.00
60	16.40	14.50

General tolerance:  $\pm 0.2$

- Socket and header are mated

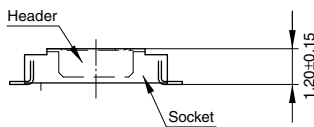

# AXK(5/6)L

## EMBOSSED TAPE DIMENSIONS (unit: mm, Common for respective contact type, socket and header)

• Tape dimensions (Conforming to JIS C 0806-1990.

• Plastic reel dimensions (Conforming to EIAJ ET-7200B)

However, some tapes have mounting hole pitches that do not comply with the standard.)

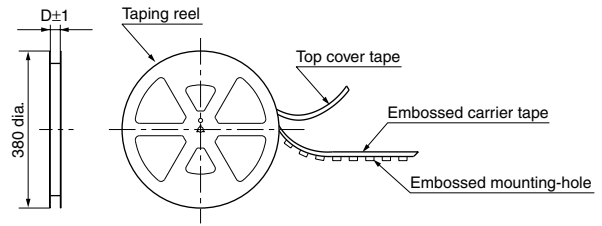
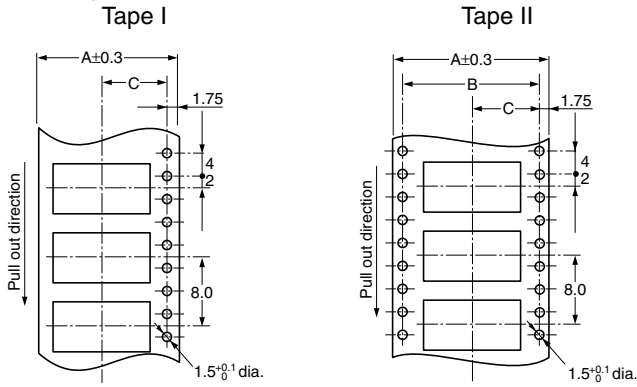

### Dimension table (mm)

Suffix: G (1 reel, 3,000 pieces embossed tape: Plastic reel package)

Mated height	No. of contacts	Type of taping	A	B	C	D	Quantity per reel
Socket and header are common: 1.2mm	10 to 18	Tape I	16.0	—	7.5	17.4	3,000 pcs.
	20 to 50	Tape I	24.0	—	11.5	25.4	3,000 pcs.
	60	Tape II	32.0	28.4	14.2	33.4	3,000 pcs.

### Connector orientation with respect to direction of progress of embossed tape

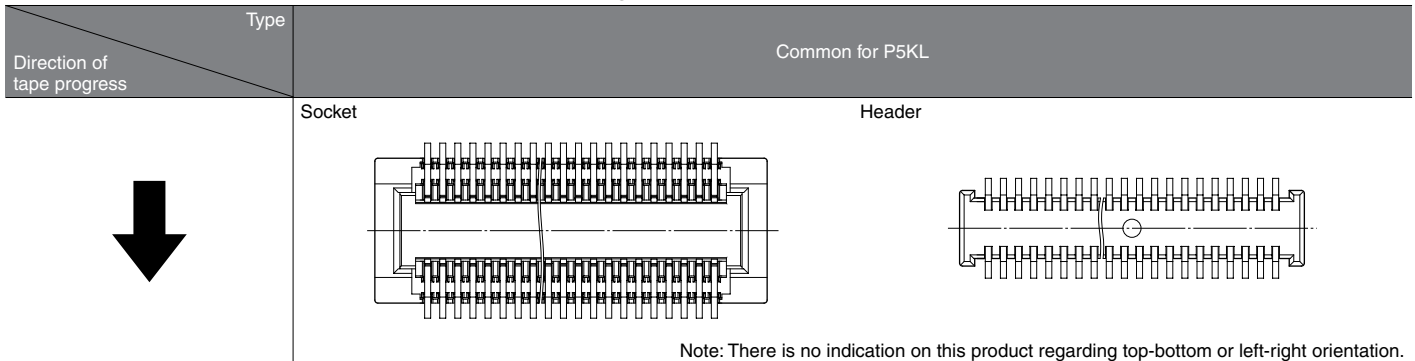

**NOTES**

1. As shown below, excess force during insertion may result in damage to the connector or removal of the solder. Please be careful. Also, to prevent connector damage please confirm the correct position before mating connectors.

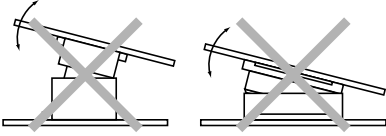

2. Keep the PC board warp no more than 0.03 mm in relation to the overall length of the connector.

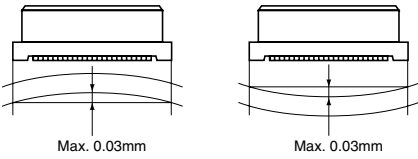

**3. PC Boards and Recommended Metal Mask Patterns**

Connectors are mounted with high density, with a pitch interval of 0.4 to 0.5 mm. It is therefore necessary to make sure that the right levels of solder are used, in order to reduce solder bridge and other issues. The figures to the right are recommended metal mask patterns. Please use them as a reference.

**• Socket**

Recommended PC board pattern (TOP VIEW)

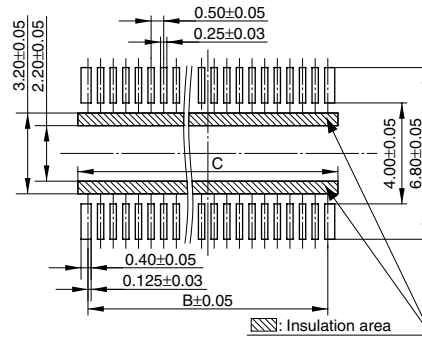

Recommended metal mask pattern  
Metal mask thickness: 150 μm  
(Terminal portion opening area ratio: 57%)

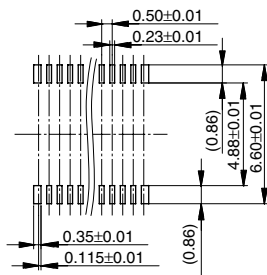

Recommended metal mask pattern  
Metal mask thickness: 120 μm  
(Terminal portion opening area ratio: 70%)

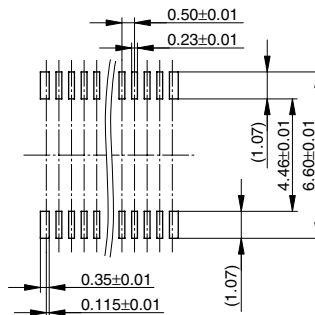

**• Header**

Recommended PC board pattern (TOP VIEW)

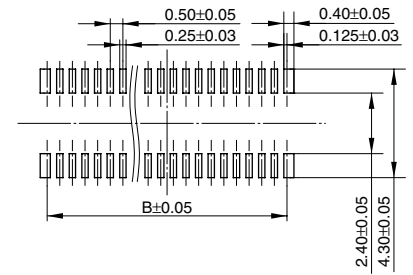

Recommended metal mask pattern  
Metal mask thickness: 150 μm  
(Terminal portion opening area ratio: 56%)

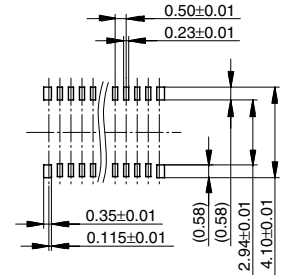

Recommended metal mask pattern  
Metal mask thickness: 120 μm  
(Terminal portion opening area ratio: 70%)

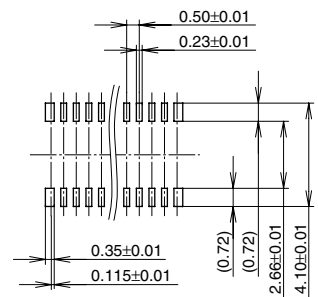

- Notes: 1. See the dimension table on page 81 for more information on the B dimension of the socket and header.
- 2. The socket C dimension is the B dimension in the dimensions table with 0.8 added.

**For other details, please verify with the product specification sheets.**